

型号

ER-3901

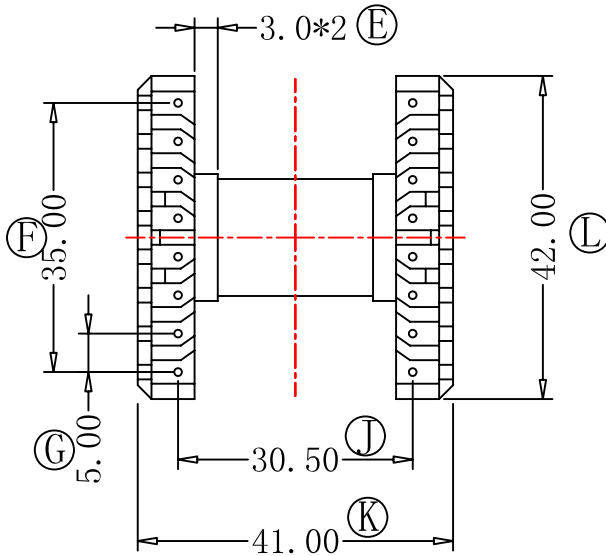
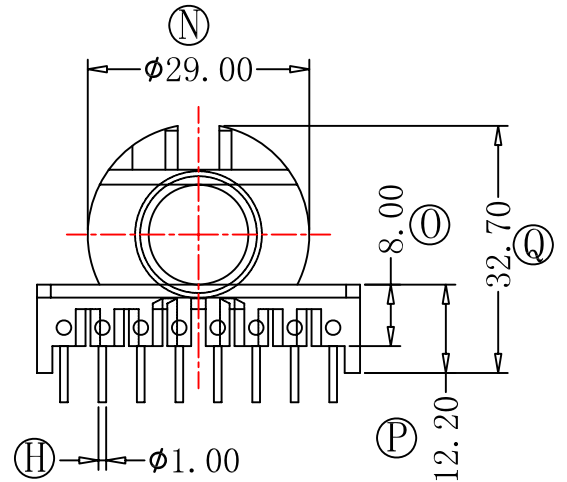
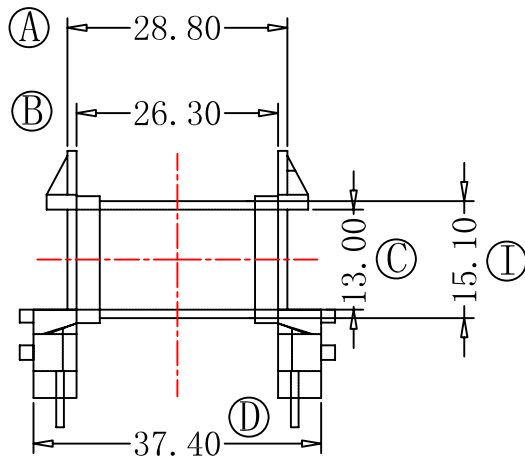
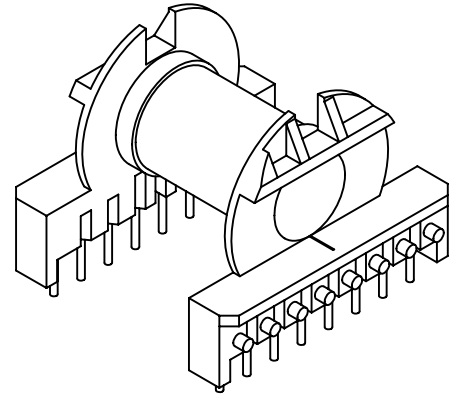
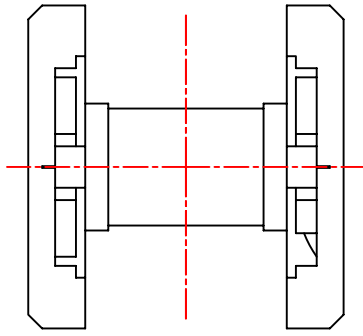

REV	DATE	REVISIONS REC

深圳市捷达成电子有限公司

SHENZHEN JIE DA CHENG ELECTRONICS CO.,LTD.

TEL:0755-27317730 FAX:0755-27317731

ANGLE:
+/-1°

MODEL NAME:
ER-3901 8+8PIN

UNIT:
MM

UL REC:
UL 94V-0

BOBBIN MATERIAL:
PHENOLIC

SCALE:
4/1

PIN TENSION LOAD:
1.0KG MIN

PIN MATERIAL:
CP WIRE

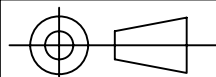

DATE:
2012-06-19

DRAWING NO:
ER-3901

REV:
1.0

DRAFTER L.R.J

TOLERANCE

0<L<4 ±0.1

4<L<16 ±0.2

16<L<50 ±0.3

PIN PITCH ±0.2

CHECKER Y.F.